



VRF SYSTEMS CONSOLE INDOOR UNIT

Installation Manual

MODELS:

AFG22MH

AFG28MH

AFG36MH

AFG45MH

AFG50MH

Thank you for choosing an Argoclima commercial air conditioner. Please read this manual carefully before using the unit and retain it for future reference.

To Users

Thank you for selecting Argoclima product. Please read this instruction manual carefully before installing and using the product, so as to master and correctly use the product. In order to guide you to correctly install and use our product and achieve expected operating effect, we hereby instruct as below:

- (1) This appliance is not intended for use by persons (including children) with reduced physical, sensory or mental capabilities, or lack of experience and knowledge, unless they have been given supervision or instruction concerning use of the appliance by a person responsible for their safety. Children should be supervised to ensure that they do not play with the appliance.
- (2) In order to ensure reliability of product, the product may consume some power under stand-by status for maintaining normal communication of system and preheating refrigerant and lubricant. If the product is not to be used for long, cut off the power supply; please energize and preheat the unit in advance before reusing it.
- (3) Please properly select the model according to actual using environment, otherwise it may impact the using convenience.
- (4) This product has gone through strict inspection and operational test before leaving the factory. In order to avoid damage due to improper disassembly and inspection, which may impact the normal operation of unit, please do not disassemble the unit by yourself. You can contact with the special maintenance center of our company if necessary.
- (5) For personal injury or property loss and damage caused by improper operation such as improper installation and debugging, unnecessary maintenance, violation of related national laws and rules and industrial standard, and violation of this instruction manual, etc., we will bear no liability.
- (6) When the product is faulted and cannot be operated, please contact with our maintenance center as soon as possible by providing the following information.
 - 1) Contents of nameplate of product (model, cooling/heating capacity, product No., ex-factory date).
 - 2) Malfunction status (specify the situations before and after the error occurs).
- (7) All the illustrations and information in the instruction manual are only for reference. In order to make the product better, we will continuously conduct improvement and innovation. We have the right to make necessary revision to the product from time to time due to the reason of sales or production, and reserve the right to revise the contents without further notice.
- (8) The final right to interpret for this instruction manual belongs to Argoclima.

Content

1	Safety Precautions	1
2	Installation of Indoor Unit	3
2.1	Indoor Unit	3
2.2	Refrigerant Piping	5
2.3	Drain Piping	6
2.4	Installing Indoor Unit	6
3	Constitutes and Names of Every Part of Indoor Unit	13
4	Working Temperature Range	15
5	Remote Controller YAP1F	15
5.1	Button name and function introduction	15
5.2	Preparation before operation	16
5.3	Introduction of operation function	16
5.4	Introduction of special functions	19
5.5	Replacing batteries in remote controller and notes	20
6	Maintenance Method	21
6.1	Units	21
6.2	Front Panel	21
6.3	Filters	22
6.4	Titanium Apatite Photocatalytic	23
6.5	Replacement	24
6.6	Before a Long Idle Period	24
7	Function Description of Functional Dial Switch S7	24
8	Malfunction Analyzing	25
8.1	Service Center	26
8.2	After-sales Service	26

1 Safety Precautions

 Warning: If not abide strictly, it may cause severe damage to the unit or the people.









 Note: If not abide strictly, it may cause slight or medium damage to the unit or the people.

 This sign indicates that the operation must be prohibited. Improper operation may cause severe damage or death to people.

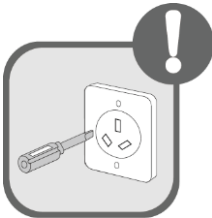









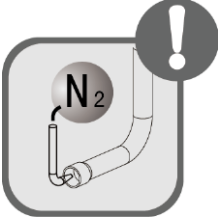

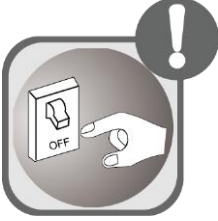
 This sign indicates that the items must be observed. Improper operation may cause damage to people or property.



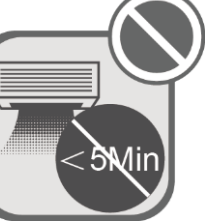

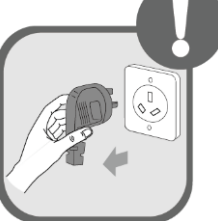
 **WARNING!**

This product can't be installed at corrosive , inflammable or explosive environment or the place with special requirements, such as kitchen. Otherwise, it will affect the normal operation or shorten the service life of the unit, or even cause fire hazard or serious injury. As for above special places, please adopt special air conditioner with anti-corrosive or anti-explosion function .

	<p>Follow this instruction to complete the installation work. Please carefully read this manual before unit startup and service.</p>		<p>Installation should be conducted by dealer or qualified personnel. Pleasdo not attempt to install the unit by yourself.Improper handling may result in water leakage, electric shock or fire disaster etc</p>
	<p>Before installation, please check if the power supply is in accordance with the requirements specified on the nameplate. And also take care of the power safety</p>		<p>Make sure the unit can be earthed properly and soundly after plugging into the socket so as to avoid electric shock. Please do not connect the ground wire to gas pipe, water pipe, lightning rod or telephone line</p>
	<p>Be sure to use the exclusive accessory and part to prevent the water leakage, electric shock and fire accidents.</p>		<p>If refrigerant leakage happens during installation, please ventilate immediately. Poisonous gas will emerge if the refrigerant gas meets fire.</p>
	<p>Wire size of power cord should be large enough.The damaged power cord and connection wire should be replaced by exclusive cable.</p>		<p>After connecting the power cord, please fix the electric box cover properly in order to avoid accident.</p>

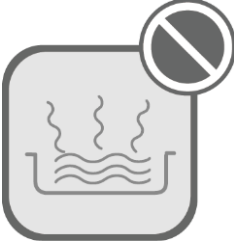
Multi Variable Air Conditioners Console Type Indoor Unit

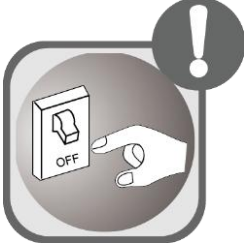
	<p>Never fail to comply with the nitrogen charge requirements. Charge nitrogen when welding pipes.</p>		<p>Never short-circuit or cancel the pressure switch to prevent unit damage.</p>
	<p>Please firstly connect the wired controller before energization, otherwise wired controller can not be used.</p>		<p>Before using the unit, please check if the piping and wiring are correct to avoid water leakage, refrigerant leakage, electric shock, or fire etc.</p>
	<p>Do not insert fingers or objects into air outlet/inlet grille</p>		<p>Keep good ventilation in the room to avoid oxygen deficit when the gas/oil supplied heating equipment is used.</p>
	<p>Never start up or shut off the air conditioner by means of directly plug or unplug the power cord.</p>		<p>Turn off the unit after it runs at least five minutes; otherwise it will influence oil return of the compressor.</p>
	<p>Do not allow children operate this unit.</p>		<p>Do not operate this unit with wet hands.</p>
	<p>Turn off the unit or cut off the power supply before cleaning the unit, otherwise electric shock or injury may happen.</p>		<p>Never spray or flush water towards unit, otherwise malfunction or electric shock may happen.</p>
	<p>Do not expose the unit to the moist or corrosive circumstances.</p>		<p>Electrify the unit 8 hours before operation. Please switch on for 8 hours before operation. Do not cut off the power when 24 hours short-time halting (to protect the compressor).</p>

	<p>Volatile liquid, such as diluent or gas will damage the unit appearance. Only use soft cloth with a little neutral detergent to clean the outer casing of unit.</p>		<p>Under cooling mode, please don't set the room temperature too low and keep the temperature difference between indoor and outdoor unit within 5 °C.</p>
	<p>If anything abnormal happens (such as burning smell), please power off the unit and cut off the main power supply, and then immediately contact Argoclima appointed service center. If abnormality keeps going, the unit might be damaged and lead to electric shock or fire.</p>		<p>User is not allowed to repair the unit. Fault service may cause electric shock or fire accidents. Please contact Argoclima appointed service center for help.</p>

2 Installation of Indoor Unit

(1) Selection of Installation location .

- 1) Such a place where cool air can be distributed throughout the room.
- 2) Such a place where condensation water is easily drained out.
- 3) Such a place that can handle the weight of indoor unit.
- 4) Such a place which has easy access for maintenance.
- 5) The appliance shall not be installed in the laundry.

(2) There are 2 styles of installation.

- 1) Wall mounted;
- 2) Floor type.

Each type is similar to the other as follows;

2.1 Indoor Unit

The indoor unit should be sited in a place where:

- (1) The restrictions on installation specified in the indoor unit installation drawings are met.
- (2) Both air intake and exhaust have clear paths met.
- (3) The unit is not in the path of direct sunlight.
- (4) The unit is away from the source of heat or steam.
- (5) There is no source of machine oil vapour (this may shorten indoor unit life).
- (6) Cool(warm) air is circulated throughout the room.
- (7) The unit is away from electronic ignition type fluorescent lamps (inverter or rapid start type) as they may shorten the remote controller range.
- (8) The unit is at least 1 metre away from any television or radio set (unit may cause interference with the picture or sound).

Cautions for Installation where air conditioner troubles liable to occur.

- 1) Where there is too much of oil area.
- 2) Where it is acid base area.

Multi Variable Air Conditioners Console Type Indoor Unit

3) Where there is irregular electrical supply.

Indoor Unit Installation Drawings

The indoor unit may be mounted in any of the three styles shown here.

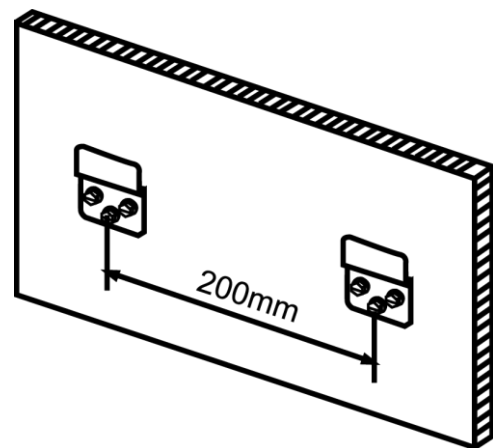
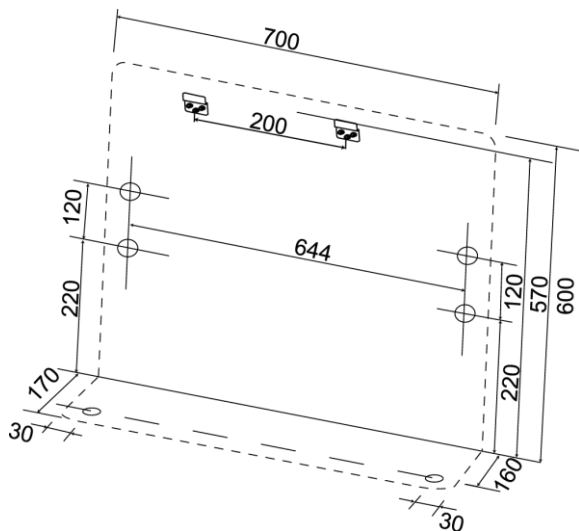
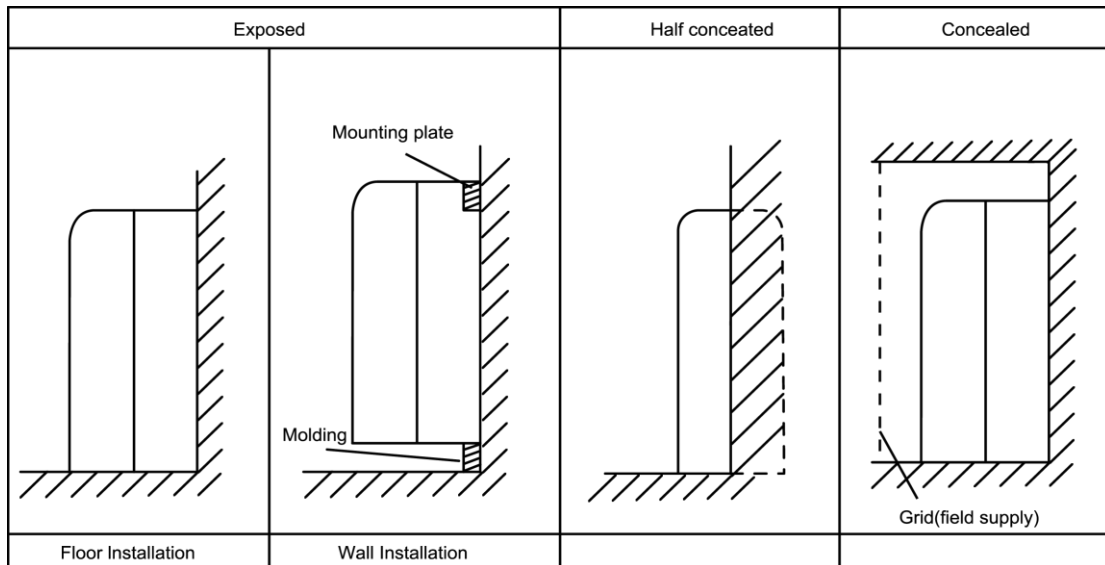

Location for securing the installation pane Schematic drawing of hooks.

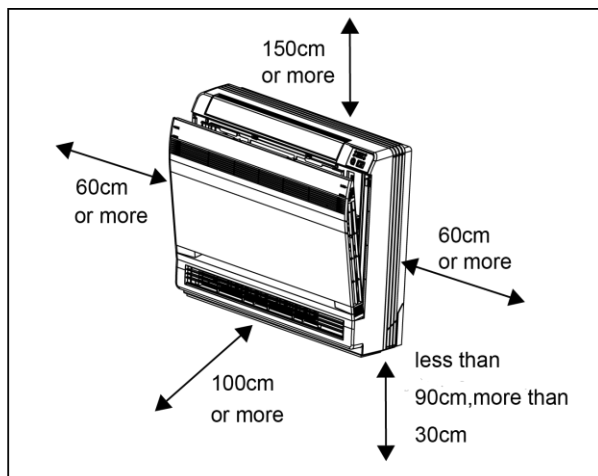
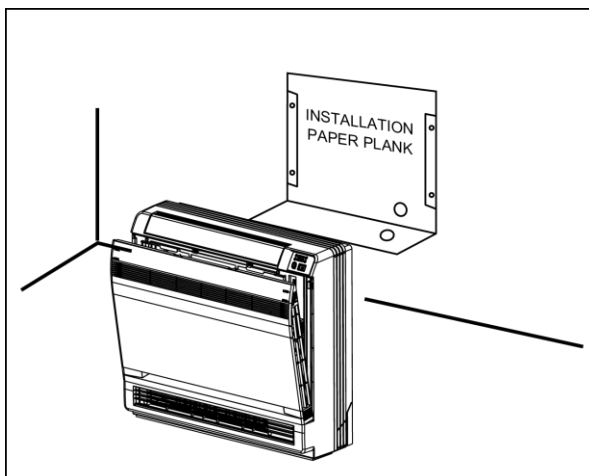

2.2 Refrigerant Piping

- (1) Drill a hole (65mm in diameter) in the spot indicated by O the symbol in the illustration ad below.
- (2) The location of the hole is different depending on which side of the pipe is taken out .
- (3) For piping ,see Connecting the refrigerant pipe ,under Indoor Unit Installation.
- (4) Allow space around the pipe for a easier indoor unit pipe connection.

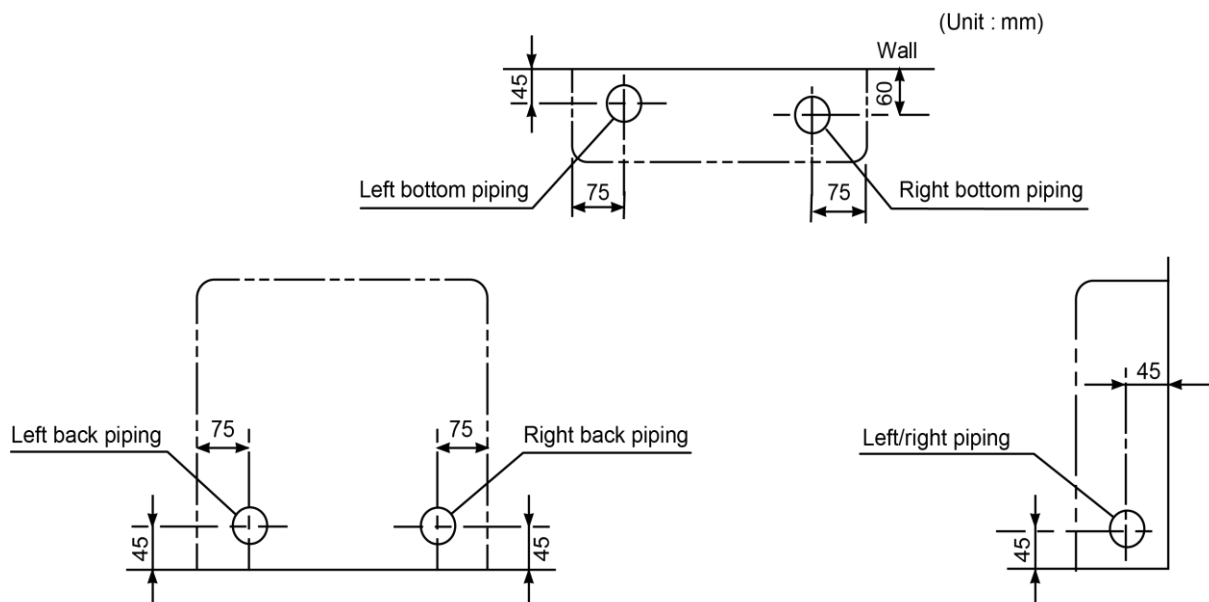

Cautions

Min. allowable length

The suggested shortest pipe length is 2.5m, in order to avoid noise from the outdoor unit and vibration. (Mechanical noise and vibration may occur depending on how the unit is installed and the environment in which it is used.)

See the installation manual for the outdoor unit for the maximum pipe length.

For multi-connections, see the installation manual for the multi-outdoor unit.

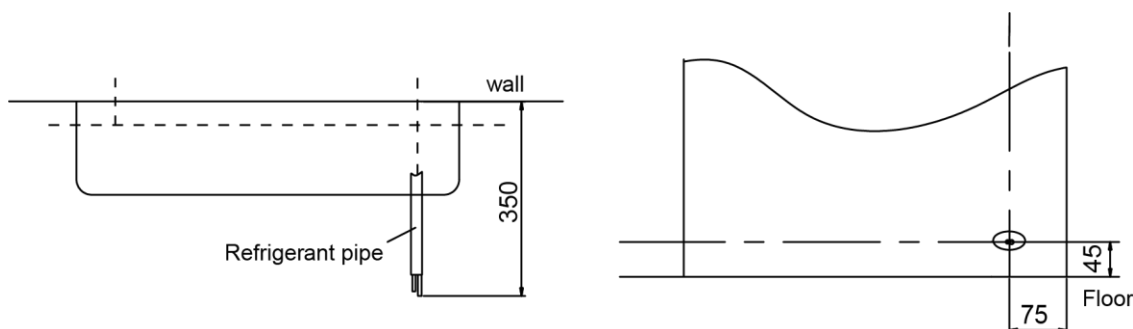

Boring a wall hole and installing wall embedded pipe

For walls containing metal frame or metal board, be sure to use a wall embedded pipe and wall cover in the feed-through hole to.

Be sure to caulk the gaps around the pipes with caulking material to prevent water leakage.

- (1) Bore a feed-through hole of 65mm in the wall so it has a down slope toward the outside.
- (2) Insert a wall pipe into the hole.

- (3) Insert a wall cover into wall pipe.
- (4) After completing refrigerant piping, wiring, and drain piping, caulk pipe hole gap with putty.

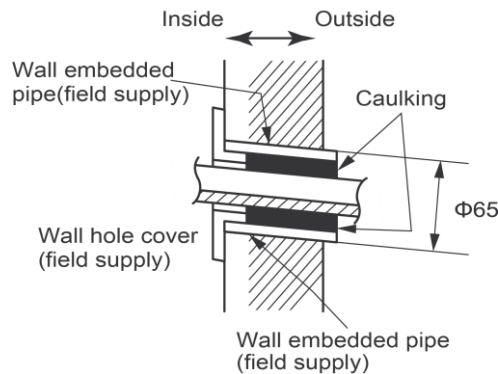

2.3 Drain Piping

- (1) Use commercial rigid polyvinyl chloride pipe general VP 20 pipe, outer diameter 26mm, inner diameter 20mm for the drain pipe.
- (2) The drain hose (outer diameter 18mm at connecting end, 220mm long) is supplied with the indoor unit. Prepare the drain pipe picture below position.
- (3) The drain pipe should be inclined downward so that water will flow smoothly without any (Should not be trap.)
- (4) Insert the drain hose to this depth so it won't be pulled out of the drain pipe.
- (5) Insulate the indoor drain pipe with 10mm or more of insulation material to prevent condensation.
- (6) Remove the air filters and pour some water into the drain pan to check the water flows smoothly.

2.4 Installing Indoor Unit

2.4.1 Preparation

- (1) Open the front panel, remove the 4 screws and dismount the front grille while pulling it forward.
- (2) Follow the arrows to disengage the clasps on the front case to remove it.
- (3) Follow the procedure below when removing the slit portions.

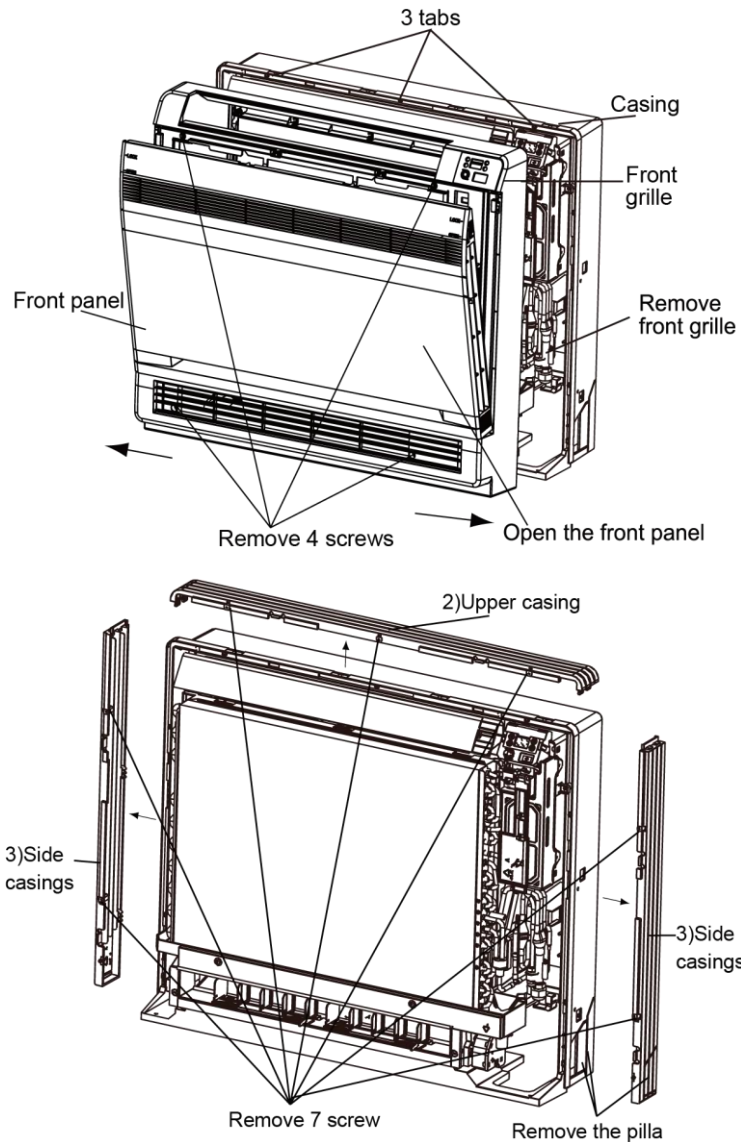

For Moldings:

Remove the pillars. (Remove the slit portions on the bottom frame using nippers.)

For Side Piping:

Remove the pillars.

- (1) Remove the 7screws.
- (2) Remove the upper casing (2 tabs).
- (3) Remove the left and right casings (2 tabs on each side).
- (4) Remove the slit portions on the bottom frame and casings using nippers.
- (5) Return by following the steps in reverse order(3>2>1).

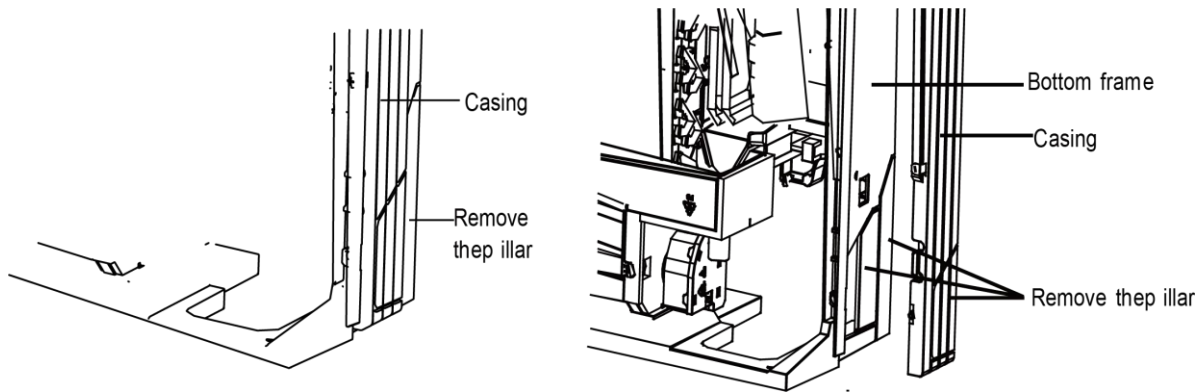

2.4.2 Installation

Secure using 6 screws for floor installations. (Do not forget to secure to the rear wall.)

For wall installations, secure the mounting plate using 5 screws and the indoor unit using 4 screws.

The mounting plate should be installed on a wall which can support the weight of the indoor unit.

- (1) Temporarily secure the mounting plate to the wall, make sure that the panel is completely level, and mark the boring points on the wall.
- (2) Secure the mounting plate to the wall with screws.

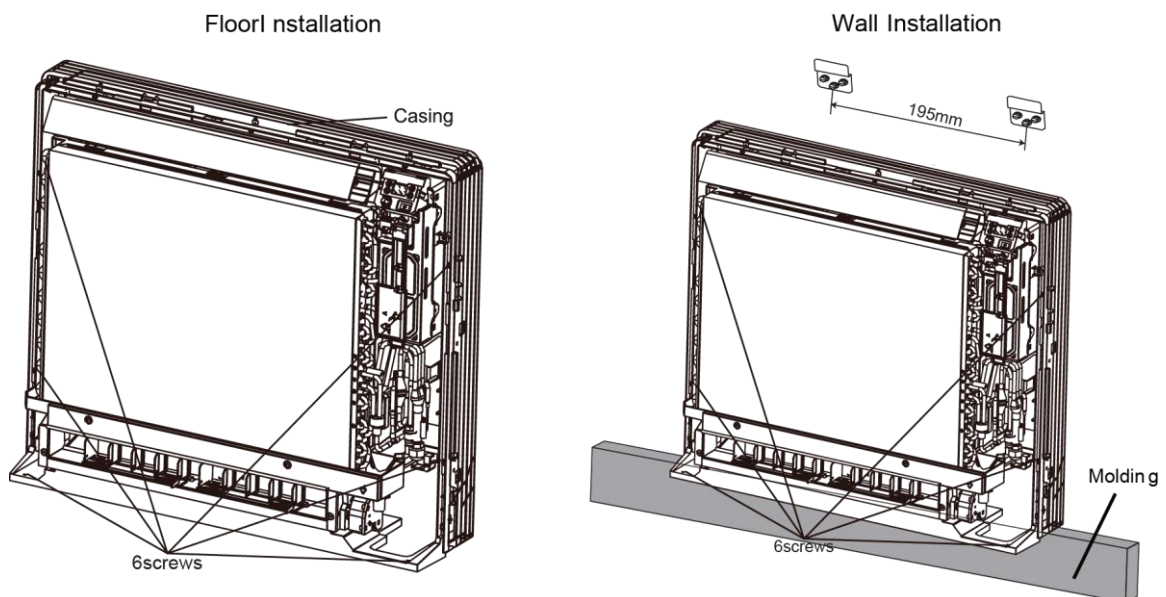

- (3) Once refrigerant piping and drain piping connections are complete, fill in the gap of the through hole with putty. A gap can lead to condensation on the refrigerant pipe, and drain pipe, and the entry of insects into the pipes.
- (4) Attach the front panel and front grille in their original positions once all connections are complete.

Flaring the pipe end

- (1) Cut the pipe end with a pipe cutter.
- (2) Remove burrs with the cut surface facing downward so that the chips do not enter the pipe.
- (3) Fit the flare nut on the pipe.

- (4) Flare the pipe.
- (5) Check that the flaring is properly made.

 **WARNING!**

- ① DO not use mineral oil on flared part.
- ② Prevent mineral oil from getting into the system as this would reduce the lifetime of the units.
- ③ Never use piping which had been used for previous installations. Only use parts which are delivered with the unit.
- ④ Do never install a drier to this R410A unit in order to guarantee its lifetime.
- ⑤ The drying material may dissolve and damage the system.
- ⑥ Incomplete flaring may cause refrigerant gas leakage.

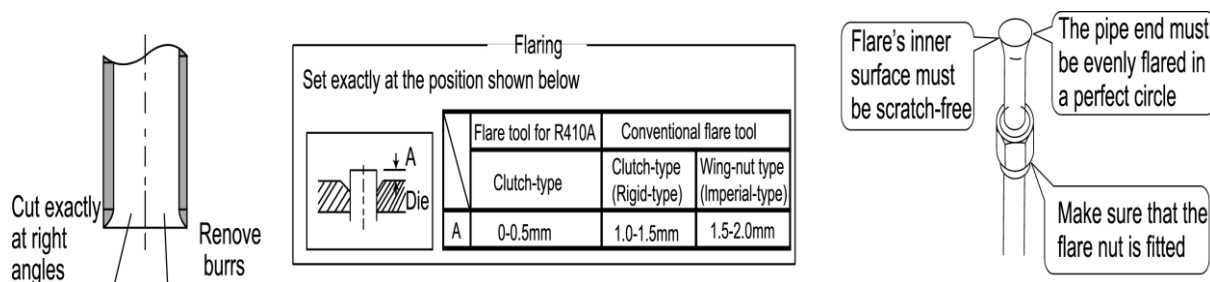

Connecting the refrigerant pipe:

- (1) Use torque wrenches when tightening the flare nuts to prevent damage to the flare nuts and gas leaks.

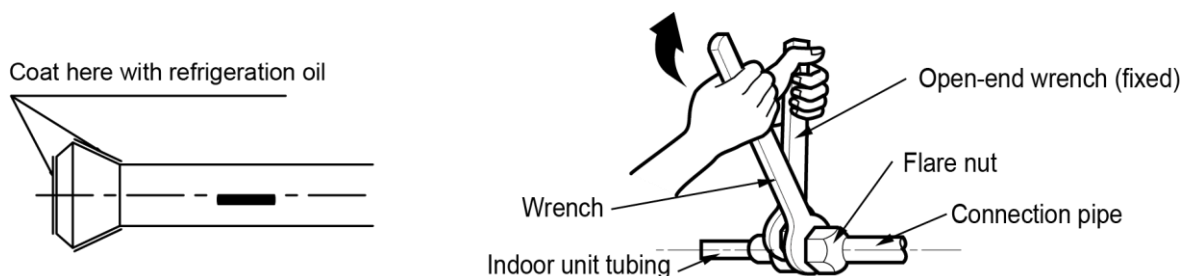

- (2) Align the centres of both flares and tighten the flares and tighten the flare nuts 3 or 4 turns by hand. Then tighten them fully with the torque wrenches.
- (3) To prevent gas leakage, apply refrigeration oil on both inner and outer surfaces in the flare. (Use refrigeration oil for R410A.)

Flare nut tightening torque		
Gas side		Liquid side
22/28 class	36/45/50 class	22/28/36/45/50 class
3/8 inch	1/2 inch	1/4 inch
32.7-39.9 N.m (333-407kfg.cm)	49.5-60.3 N.m (505-615kfg.cm)	14.2-17.2 N.m (144-175kfg.cm)

Caution on piping handling:

- (1) Protect the open end of the pipe against dust and moisture.
- (2) All pipe bends should be as gentle as possible. Use a pipe bender for bending.

Multi Variable Air Conditioners Console Type Indoor Unit

(Bending radius should be 30 to 40mm or larger.)

Selection of copper and heat insulation materials:

When using commercial copper pipes and fittings, observe the following:

(1) Insulation material: Polyethylene foam

Heat transfer rate: 0.041 to 0.052W/mK (0.035 to 0.045kca/(mh^{°C}))

Refrigerant gas pipe's surface temperature reaches 110 max.

Choose heat insulation materials that will withstand this temperature.

(2) Be sure to insulate both the gas and liquid piping and to provide insulation dimensions as below.

Gas side		Liquid side	Gas pipe thermal insulation		Liquid pipe thermal insulation
22/28 class	36/45/50 class	-	22/28 class	36/45/50 class	-
O.D.9.52mm	O.D.12.7mm	O.D.6.4mm	I.D.12-15mm	I.D.14-16mm	I.D.8-10mm
Thickness 0.8mm			Thickness 10mm Min.		

(3) Use separate thermal insulation pipes for gas and liquid refrigerant pipes.

Checking for gas leakage

(1) Check for leakage of gas after air purging

(2) See the sections on air purges and gas leak checks in the installation manual for the outdoor unit.

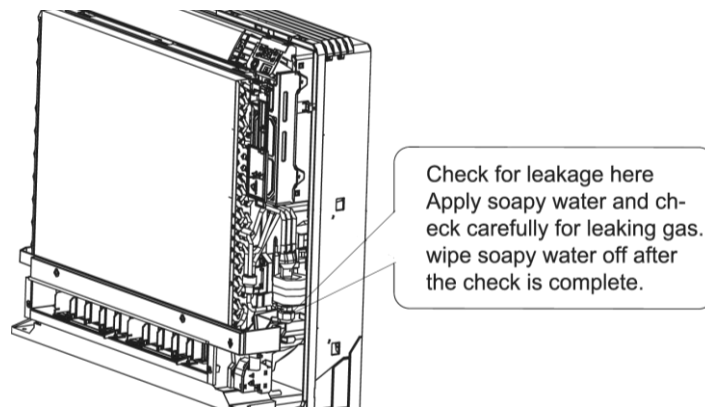

Attaching the connection pipe

Attach the pipe after checking for gas leakage, described above.

(1) Cut the insulated portion of the on-site piping, matching it up with the connecting portion.

(2) Secure the slit on the refrigerant piping side with the butt joint on the auxiliary piping using the tape, making sure there are no gaps.

(3) Wrap the slit and butt joint with the included insulation sheet, making sure there are no gaps.

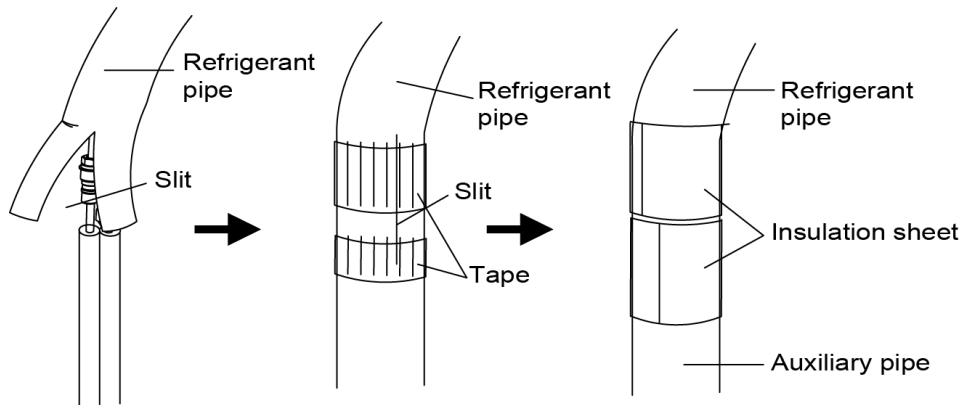

CAUTION!

- ① Insulate the joint of the pipes securely. Incomplete insulation may lead to water leakage.
- ② Push the pipe inside so it does not place undue force on the front grille.

Connecting the drain hose

Insert the supplied C drain hose into the socket of the drain pan.

Fully insert the drain hose until it adheres to a seat of the socket.

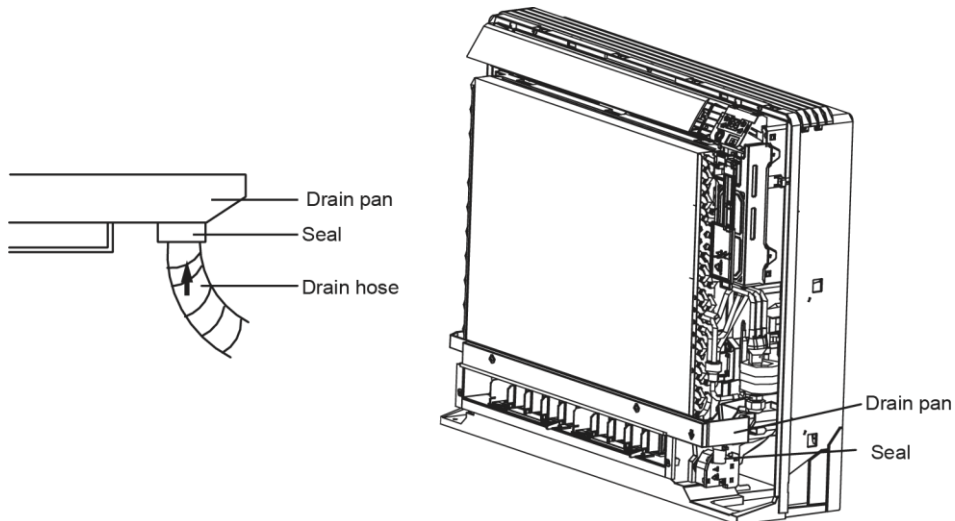

WARNING!

With a Multi indoor unit, install as described in the installation manual supplied with the outdoor unit.

Live the sensor securing plate, remove the front metal plate cover, and connect the wire to the terminal board.

- (1) Open the cover of electric box of indoor unit.
- (2) Lead the communication line across the rubber ring.
- (3) Connect the communication line to terminal D1 and D2 on the wiring board of indoor unit.
- (4) Secure the communication line with the wire clamp on the electric box. Pull wires to make sure that they are securely latches up, then retain wires with wire retainer.

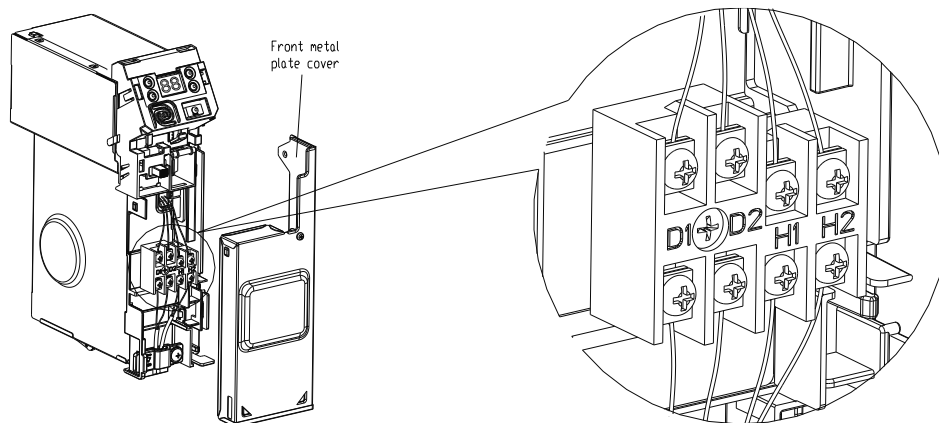

! NOTES!

The power of every indoor unit should be unity power supply.

- (1) The power connection cord have been inserted on the mainboard through the piping hole of the chassis. Please connect the power connection cord with the breaker. If the power cord is not long enough, please prolong it with terminal block.

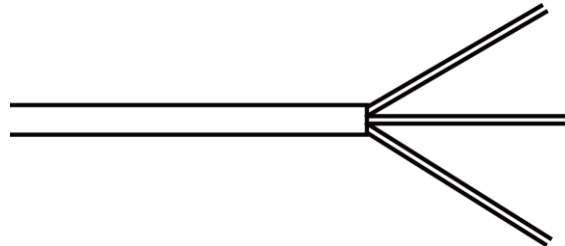

- (2) Reinstall the wiring cover on the original place and tighten the bolt;
- (3) Recover the surface panel.

! CAUTION!

- ① Do not use tapped wires, stranded wires, extension cords, or starburst connections, as they may cause overheating, electrical shock, or fire.
- ② Do not use locally purchased electrical parts inside the product. (Do not branch the power for the drain pump, etc, from the terminal block.) Doing so may cause electric shock or fire.)

Install the drainage pipe

- (1) For well draining, the drain hose should be placed at a downward slant.
- (2) Do not wrench or bend the drain hose or flood its end by water.
- (3) Wrap heat resistant material when connect the longer drainage tube though indoor.

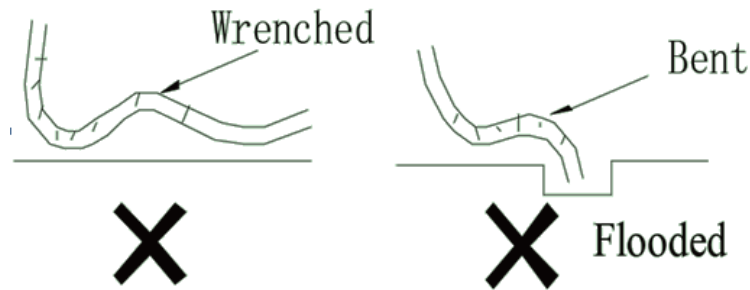

Install the connection pipes

Connect the connect pipe with the two relative leading pipe, tie the nut on tie in of the connect pipe tightly.

! NOTES!

- ① Be careful in bending the connection pipes, or you will damage the pipes.
- ② If the tightening torque is too great in tightening the flare nut, leakage will happen.

3 Constitutes and Names of Every Part of Indoor Unit

! CAUTION!

- ① Before opening the front panel, be sure to stop the operation and turn the breaker OFF.
- ② Do not touch the metal parts on the inside of the indoor unit, as it may result in injury.

(1) Titanium Apatite Photocatalytic

Air-Purifying Filter:

These filters are attached to the inside of the air filters.

- (2) Air outlet
- (3) Display
- (4) Front panel
- (5) Louvers (vertical blades)

The louvers are inside of the air outlet.

- (6) Air inlet
- (7) Air filter
- (8) Flap (horizontal blade)
- (9) Cool mode lamp
- (10) Heat mode lamp
- (11) Dry mode lamp
- (12) Run lamp
- (13) LED display

(14) Indoor Unit ON/OFF switch:

- 1) Push this switch once to start operation.
- 2) Push once again to stop it.

Multi Variable Air Conditioners Console Type Indoor Unit

3) The operation mode refers to the following table.

Model	Mode	Temperature setting	Air flow rate
HEAT PUMP	AUTO	26°C	AUTO

4) This switch is useful when the remote controller is missing.

(15) Signal receiver:

- 1) It receives signals from the remote controller.
- 2) When the unit receives a signal, you will hear a short beep.
- 3) Settings changed beep.

(16) Air outlet selection switch.

It senses the air temperature around the unit.

! NOTES!

- ① If the supply cord is damaged, it must be replaced by the manufacturer or its service agent or a similarly qualified person in order to avoid a hazard.
- ② The appliance shall be installed in accordance with national wiring regulations.
- ③ An all-pole disconnection switch having a contact separation of at least 3mm in all poles should be connected in fixed wiring.
- ④ An all-pole disconnection switch having a contact separation of at least 3mm in all poles should be connected in fixed wiring.

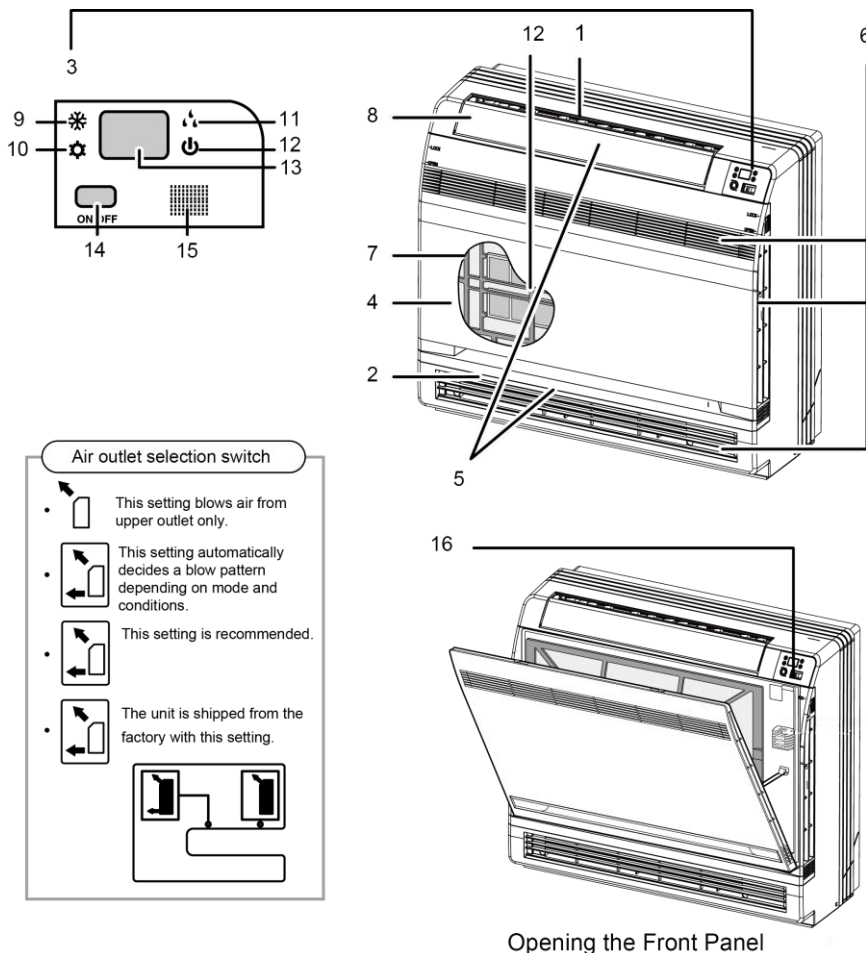





4 Working Temperature Range

	Indoor side state		Outdoor side state	
	Dry bulb temp°C	Wet bulb temp°C	Dry bulb temp°C	Wet bulb temp°C
Rated Cooling	27	19	35	24
Max. cooling	32	23	43	26
Min. cooling	21	15	18	—
Rated Heating	20	15	7	6
Max. heating	27	—	24	18
Min. heating	20	15	-15	-16

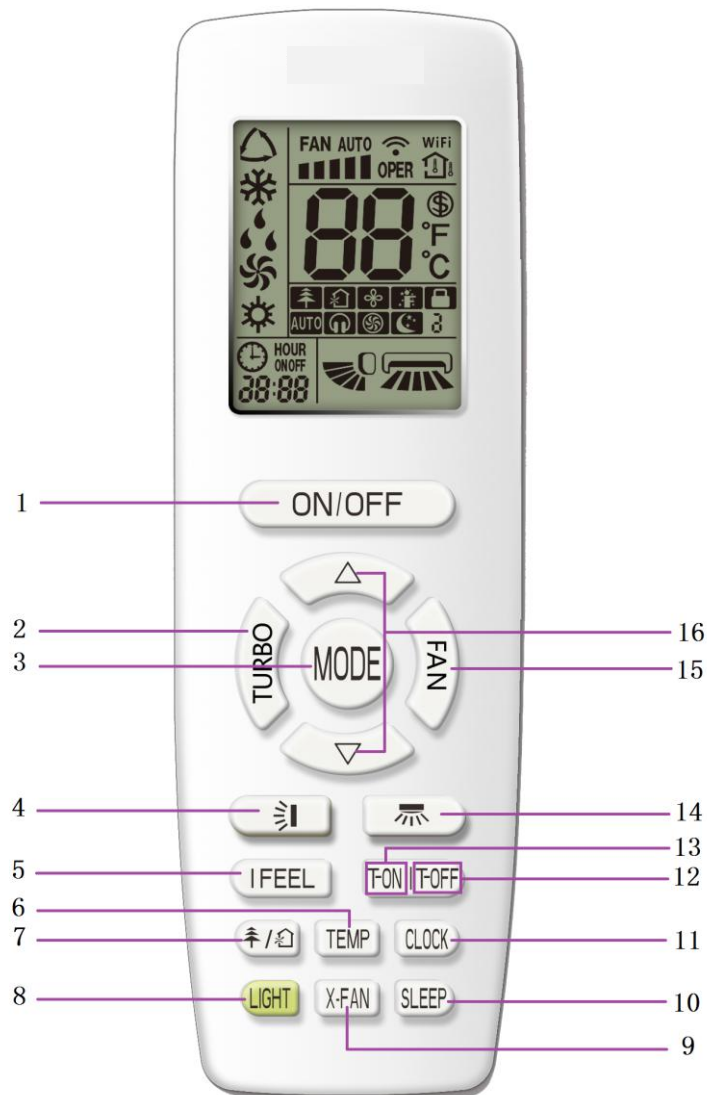
5 Remote Controller

5.1 Button name and function introduction



No.	Button name	Function
1	ON/OFF	Turn on or turn off the unit
2	TURBO	Set turbo function
3	MODE	Set operation mode
4		Set up&down swing status
5	I FEEL	Set I FEEL function
6	TEMP	Switch temperature displaying type on the unit's display
7		Set health function and air function
8	LIGHT	Set light function
9	X-FAN	Set X-FAN function
10	SLEEP	Set sleep function
11	CLOCK	Set clock of the system
12	TOFF	Set timer off function
13	TON	Set timer on function
14		Set left&right swing status
15	FAN	Set fan speed
16	Δ/∇	Set temperature and time

5.2 Preparation before operation

When using the remote controller for the first time or after replacing the batteries, please set the time of the system according to current time in the following steps:

- (1) Pressing CLOCK button,  is blinking.
- (2) Pressing Δ or ∇ button, the clock time will increase or decrease rapidly.
- (3) Press CLOCK button again to confirm the time and return to display current time.

5.3 Introduction of operation function

- (1) Selecting operation mode

In unit on status, press MODE button to select operation mode in following sequence:



- (2) Setting temperature

In unit on status, press Δ button to increase setting temperature and press ∇ button to decrease setting temperature. The range of temperature is from 16°C to 30°C.

NOTES!

Under auto mode, manual adjustment of temperature is not needed.

- (3) Adjusting fan speed

In unit on status, press FAN button to adjust fan speed in following sequence:

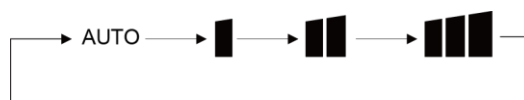

! NOTES!

- ① When operation mode changes, fan speed is memoried;
- ② Under dry mode, fan speed is low and can not be adjusted.

(4) Setting swing function

1)Setting left&right swing

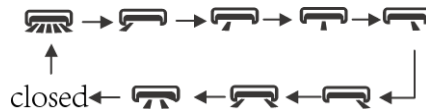

- a) Under simple swing status, press  button to adjust left&right swing status;
- b) Under fixed-angle swing status, press  button to adjust left&right swing angle circularly as below:



! NOTES!

operate continuously left&right swing in 2 seconds, swing states will change according to above-mentioned order, or switch closed state and  state.

2)Setting up&down swing

- a) Under simple swing status, press  button to adjust up&down swing status;
- b) Under fixed-angle swing status, press  button to adjust up&down swing angle circularly as below:





! NOTES!

operate continuously left&right swing in 2 seconds, swing states will change according to above-mentioned order, or switch closed state and  state;

(5) Setting turbo function

Under cool or heat mode, press TURBO button to set turbo function.



- 1)When  is displayed, turbo function is on.
- 2)When  is not displayed, turbo function is off.
- 3)When turbo function is on, the unit operates in super high speed to achieve quick cooling or heating. When turbo function is off, the unit operates in setting fan speed.

(6) Setting light function

The light on the receiver light board will display present operation status. If you want to turn off the light, please press LIGHT button. Press this button again to turn on the light.

(7) Viewing ambient temperature

In unit on status, receiver light board or wired controller is defaulted to display setting temperature. Press TEMP button to view indoor or outdoor ambient temperature.

- 1)When  is displayed, it means the displayed temperature is setting temperature.
- 2)When  is displayed, it means the displayed temperature is indoor ambient

temperature.



- 3) When  is displayed, it means the displayed temperature is outdoor ambient temperature.

NOTES!

setting temperature is always displayed in Remote Controller.



(8) Setting X-FAN function

In cool or dry mode, press X-FAN button to set X-FAN function.

- 1) When  is displayed, X-FAN function is on.
- 2) When  is not displayed, X-FAN function is off.
- 3) When X-FAN function is on, the water on the evaporator will be blown away until turning off the unit to avoid mildew.





(9) Setting health function

In unit on status, press  button to set health function.

- 1) When  is displayed, health function is on.
- 2) When  is not displayed, health function is off.

Health function is available when the unit is equipped with anion generator. When health function is on, the anion generator will start operation, adsorbing the dusts and killing the bacteria in the room.



(10) Setting air function

- 1) Press  button until  is displayed, then air function is turned on.
- 2) Press  button until  is disappeared, then air function is turned off.

When the indoor unit is connected with fresh air valve, air function setting can control the connection of fresh air valve, which can control the fresh air volume and improve the air quality inside the room.

(11) Setting sleep function

In unit on status, press SLEEP button to turn on or turn off sleep function.



- 1) When  is displayed, sleep function is on.
- 2) When  is not displayed, sleep function is off.

NOTES!

- ① Sleep function can not be set in auto and fan mode;
- ② When turning off the unit or switching mode, sleep function is cancelled;

(12) Setting I FEEL function

In unit on status, press I FEEL button to turn on or turn off I FEEL function.

- 1) When  is displayed, I FEEL function is on.
- 2) When  is not displayed, I FEEL function is off.
- 3) When I FEEL function is turned on, the unit will adjust temperature according to the

temperature detected by the remote controller to achieve the best air-conditioning effect. In this case, you should place the remote controller within the valid receiving range.

(13) Setting timer

You can set the operation time of unit as you need. You can also set timer on and timer off in combination.

Before setting, check if the time of the system is the same as the current time. If not, please set the time according to current time.

1) Setting timer off

- a) Pressing TOFF button, "OFF" is blinking and time displaying zone displays the timer time of last setting.
- b) Press Δ or ∇ button to adjust the timer time.
- c) Press TOFF button again to confirm setting. OFF is displayed and time displaying zone resumes to display current time.
- d) Press TOFF button again to cancel timer and OFF is not displayed.

2) Setting timer on

- a) Pressing TON button, "ON" is blinking and time displaying zone displays the timer time of last setting.
- b) Press Δ or ∇ button to adjust the timer time.
- c) Press TON button again to confirm setting. ON is displayed and time displaying zone resumes to display current time.
- d) Press TON button again to cancel timer and ON is not displayed.

5.4 Introduction of special functions

(1) Setting child lock

Press Δ and ∇ button simultaneously to lock the buttons on remote controller and  is displayed.

Press Δ and ∇ button simultaneously again to unlock the buttons on remote controller and  is not displayed.

If the buttons are locked,  blinks 3 times when pressing the button and any operation on the button is invalid.

(2) Switching temperature scale

In unit off status, press MODE button and ∇ button simultaneously to switch temperature scale between $^{\circ}\text{C}$ and $^{\circ}\text{F}$.

(3) Setting energy-saving function

In unit on status and under cool mode, press CLOCK and TEMP button simultaneously to enter energy-saving mode.

1) When  is displayed, energy-saving function is on.

2) When  is not displayed, energy-saving function is off.

If you want to turn off the energy-saving function, press CLOCK and TEMP button and  is

not displayed.

! NOTES!

energy-saving function is only available in cooling mode and it will be exited when switching mode or setting sleep function.

(4) Absence function

In unit on status and under heat mode, press CLOCK and TEMP button simultaneously to enter absence function. Temperature displaying zone displays 8 and Ⓢ is displayed.

Press CLOCK and TEMP button simultaneously again to exit absence function. Temperature displaying zone resumes previous display and is not displayed.

In winter, absence function can keep the indoor ambient temperature above 0°C to avoid freezing.

! NOTES!

Absence function is only available in heating mode and it will be exited when switching mode or setting sleep function.

5.5 Replacing batteries in remote controller and notes

- (1) Lift the cover along the direction of arrow (as shown in Fig 1①).
- (2) Take out the original batteries (as shown in Fig 1②).
- (3) Place two 7# (AAA 1.5V) dry batteries, and make sure the position of “+” polar and “-” polar is correct (as shown in Fig 2③).
- (4) Reinstall the cover (as shown in Fig 2④).

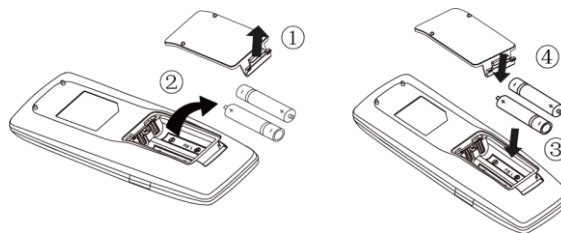

Fig.1

Fig.2

! NOTES!

- ① The remote controller should be placed 1m away from the TV set or stereo sound sets.
- ② The operation of remote controller should be performed within its receiving range.
- ③ If the remote controller does not operate normally, please take the batteries out and reinsert them after 30 seconds. If it still can't operate properly, replace the batteries.
- ④ When replacing the batteries, do not use old or different types of batteries, otherwise, it may cause malfunction.
- ⑤ When you won't use the remote controller for a long time, please take out the batteries.

6 Maintenance Method

Before inspection and maintenance of the unit. PLEASE set power switch to "OFF" to cut off the power supply.

6.1 Units

Indoor unit, Outdoor unit and Remote controller

Wipe them with dry soft cloth.

6.2 Front Panel

(1) Open the front panel.

(2) Remove the air filter.

Slide the two stoppers on the left and right sides inward until they click.

(3) Remove the front panel.

1) Remove the string.

2) Allowing the front panel to fall forward will enable you to remove it.

(4) Clean the front panel.

1) Wipe it with a soft cloth soaked in water.

2) Only neutral detergent may be used.

3) In case of washing the front panel with water, dry it with cloth, dry it up in the shade after washing.

(5) Attach the front panel.

1) Insert the front panel into the grooves of the unit (3 places).

2) Attach the string to the right, inner-side of the front grille.

3) Close the panel slowly.



CAUTION!

- ① Don't touch the metal parts of the indoor unit. If you touch those parts, this may cause an injury.
- ② When removing or attaching the front panel, use a robust and stable stool and watch your steps carefully.
- ③ When removing or attaching the front panel, support the panel securely with hand to prevent it from falling.
- ④ For cleaning, do not use hot water above 40°C, benzine, gasoline, thinner, nor other volatile oils, polishing compound, scrubbing brushes, nor other hand stuff.
- ⑤ After cleaning, make sure that the front panel is securely fixed.

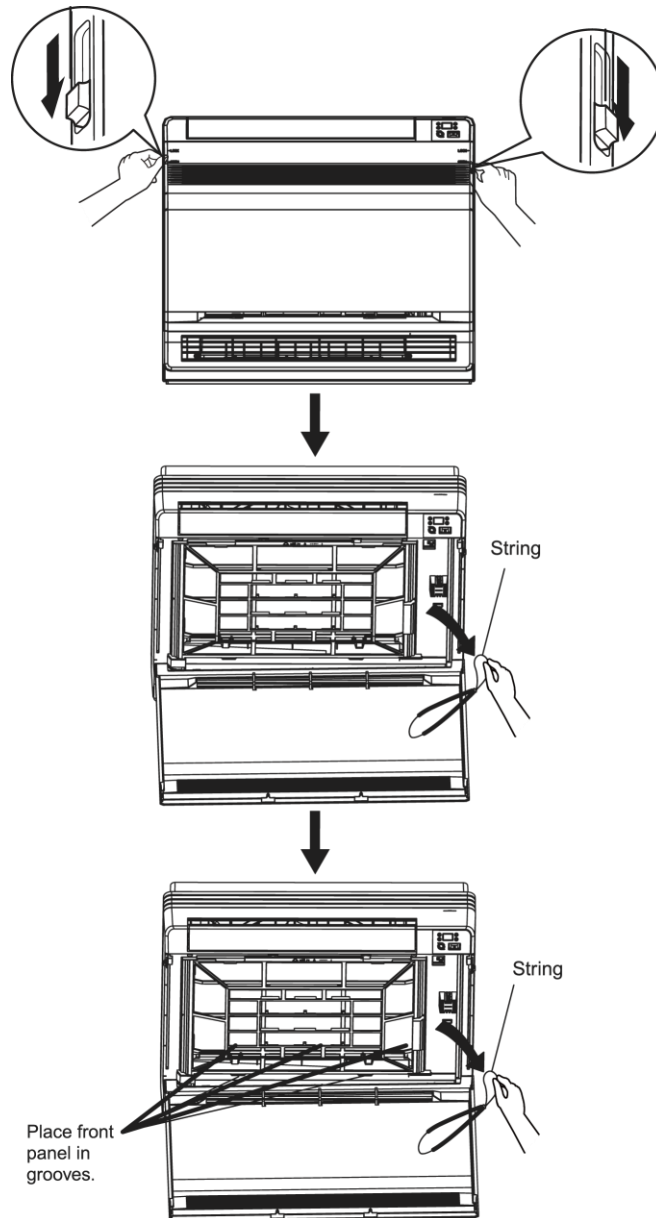

6.3 Filters

- (1) Open the front panel.
- (2) Remove the air filter.

Press the claws on the right and left of the air filter down slightly, then pull upward.

- (3) Take off the Titanium Apatite Photocatalytic Air-Purifying Filter.

Hold the tabs of the frame, and remove the claws in 4 places.

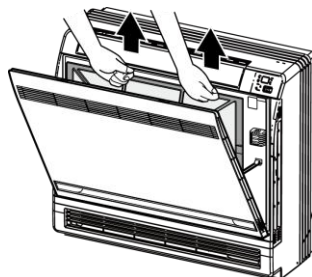

- (4) Clean or replace each filter.

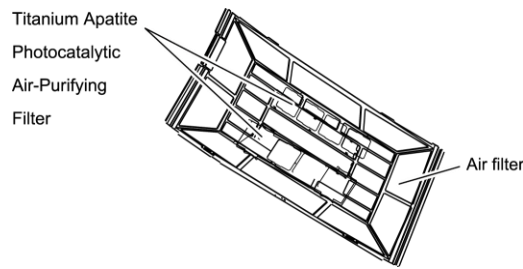

- (5) Set the air filter and Titanium Apatite Photocatalytic Air-Purifying Filter as they were and close the front panel.

Operation without air filters may result in troubles as dust will accumulate inside the indoor unit.

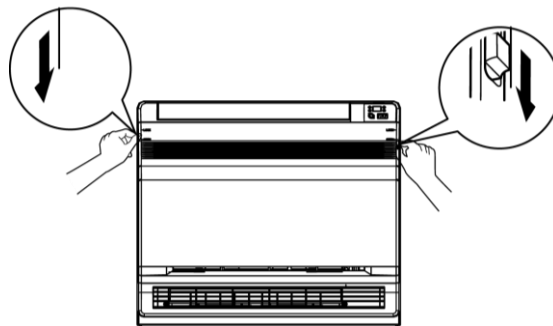

- (6) Wash the air filters with water or clean them with vacuum cleaner
- (1) If the dust does not come off easily, wash them with neutral detergent thinned with lukewarm water, then dry them up in the shade.
 - (2) It is recommended to clean the air filters every week.

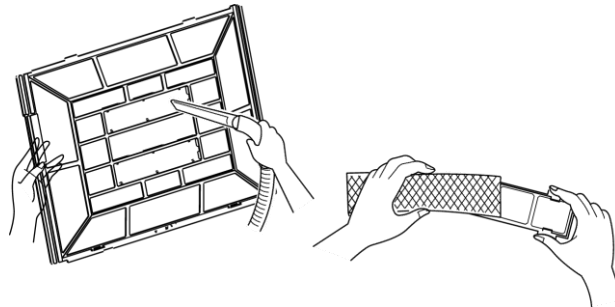

6.4 Titanium Apatite Photocatalytic

Air-Purifying Filter

The Titanium Apatite Photocatalytic Air-Purifying Filter can be renewed by washing it with water once every 6 months. We recommend replacing it once every 3 years.

- (1) Vacuum dusts, and soak in warm water or water for about 10 to 15 minutes if dirt is heavy.
- (2) Do not remove filter from frame when washing with water.
- (3) After washing, shake off remaining water and dry in the shade.
- (4) Since the material is made out of paper, do not wring out the filter when removing water from it.

6.5 Replacement

Remove the tabs on the filter frame and replace with a new filter.

- (1) Dispose of the old filter as flammable waste.
- (2) Dispose of the old filter as flammable waste.

NOTES!

Operation with dirty filters

- ① Cannot deodorize the air.
- ② Cannot clean the air.

Results in poor heating or cooling.

- ③ may cause odour.

NOTES!

- ① Check that the base, stand and other fittings of the outdoor unit are not decayed or corroded.
- ② Check that nothing blocks the air inlets and the outlets of the indoor unit and the outdoor unit.
- ③ Check that the drain comes smoothly out of the drain hose during COOL or DRY operation.
- ④ If no drain water is seen, water may be leaking from the indoor unit. Stop operation and consult the service shop if this is the case.

6.6 Before a Long Idle Period

- (1) Operate the “FAN only” for several hours on a fine day to dry out the inside.
 - 1) Press “MODE” button and select “FAN” operation.
 - 2) Press “ON/OFF” button and start operation.
- (2) After operation stops, turn off the breaker for the room air conditioner.
- (3) Clean the air filters and set them again.
- (4) Take out batteries from the remote controller.

NOTES!

When a multi outdoor unit is connected, make sure the heating operation is not used at the other room before you use the fan operation.

7 Function Description of Functional Dial Switch S7

- (1) The 3-bit dial switch must be set before energizing the main board and it determines running state of indoor unit.
- (2) Function of it is as follow:

Dial switch Silk screen	Function	Dial ON	Dial OFF
1(S / R)	Selection of memory mode: A. Election between reset mode and standby mode after energizing; B. This function is available without wired controller.	Standby after energizing	Reset after energizing
2(L / I)	Selection between manual controller and receiver: A. If manual controller is selected, remote-control function of receiver will be shielded; B. If receiver is selected, wired controller will be non-effective.	Selecting wired controller	Selecting receiver joint

8 Malfunction Analyzing



WARNING!

Do not repair air conditioner by yourself for the incorrect repair would lead electric shock or fire. Please contact service center and had the unit repaired by specialized personnel. Check the following item before contacting to repair could save your time and cost.

Malfunction Phenomena	Malfunction Analyzing
The air conditioner can't start up just after turned off	The over load protect switch of the unit makes it runs after 3 mins delay
Odor gave out when the unit just turned on	This is because when air conditioning, odors or cigarette smoke from the room that was sucked in is discharged again.
Slight bicker was heard when the unit is running	This is the sound for inner refrigerant flowing
Mist come from air outlet vent when cooling	Indoor air is cooled rapidly
Creak sound is heard when running or after run	The grating sound caused by expands of panel and other parts for the change of temperature.
The air conditioner cannot run	Is power cut ? Is the power supply connected ? Is the circuit protector started aside ? Is the voltage too high or too low ? If TIMER had been set in wireless remote controller ?
The cooling (heating) effect of the air conditioner is not good	Is the temp. set in proper ? Is the inlet, outlet vent of outdoor unit blocked ? Is the air filter too dirty to cause blockage ? Are windows and doors closed ? Is air quantity set to Low speed ? Is there other heating resource in room ?
Wireless remote controller cannot control	Under the circumstance of changed batteries, the wireless remote controller sometimes would appear the phenomena of couldn't control. Take out the back cover and press "ACL" button to make it normal. The air conditioner is under abnormal disturbance or changing function too frequently, to make wireless remote controller cannot control. Cut off main power switch and re-electrify could resume normal operation. Is the controller within the receiving area? Or is there blockage? Check if the voltages of batteries in wireless remote controller are enough; Otherwise change the batteries.

8.1 Service Center

When the following phenomena appeared, please stop operating immediately, cut off main power supply of unit and contact service center for the conditioner.

- (1) Harsh sound heard when running;
- (2) The fuse or protector cut frequently;
- (3) Substance or water pulled in the unit involuntary;
- (4) Water leakage in room;
- (5) Over heat of power cord;
- (6) Odor is given out when running;

8.2 After-sales Service

When having quality or other problems when purchasing air conditioner, please contact the local service center.



improve your life

www.argoclima.com